

iQ500, Fully-integrated dishwasher, 60 cm, varioHinge SN95YX02CG



The Energy Label A dishwasher, thanks to our Intelligent Energy Saving Solutions with no constraining compromises to perfect results.

- ✓ Optimal installation in your kitchen – varioHinge.
- ✓ Intelligent Programme: customised dishwashing to suits your needs.
- ✓ Zeolith® drying – Quicker dishwasher drying that uses less energy.
- ✓ glassZone – Dedicated dishwasher zone that protects your glassware.
- ✓ Home Connect – Control your smart dishwasher, no matter where you are.

Features

Technical Data

Energy Efficiency Class:A
 Energy Consumption for 100 cycles Eco Programme: 54 kWh
 Maximum number of place settings: 14
 The water consumption of the eco programme in liters per cycle: 9.5 l
 Programme duration:4:55 h
 Airborne acoustical noise emissions : 44 dB(A) re 1 pW
 Airborne acoustical noise emission class:B
 Built-in / Free-standing: Built-in
 Height of removable worktop:0 mm
 Dimensions of the product: 815 x 598 x 550 mm
 Min. required niche size for installation (HxWxD): ..815-875 x 600 x 550 mm
 Depth with open door 90 degree:1150 mm
 Adjustable feet: Yes - all from front
 Maximum adjustability feet: 60 mm
 Adjustable plinth:Both horizontal and vertical
 Weight: 47.2 kg
 Gross weight: 49.0 kg
 Connection Rating: 2400 W
 Fuse protection:10 A
 Nominal power: 220-240 V
 Frequency:50; 60 Hz
 Length electrical supply cord: 175.0 cm
 Plug type: GB plug
 Length inlet hose: 165 cm
 Length outlet hose: 190 cm
 EAN code:4242003958988
 Installation type: Fully integrated



Optional accessories

SZ30BI01	decorative strips stainless steel 81,5cm
SZ38BI00	Connection rail for divided furniture
SZ72010	inlet and outlet hose extension 2 m
SZ73000	Dishwashing aid set
SZ73035	panel strips, elevated install. 81,5cm
SZ73100	cutlery basket
SZ73300	Wineglass-Tray
SZ73640	Rack insert for stemware dishwasher

iQ500, Fully-integrated dishwasher, 60 cm, varioHinge SN95YX02CG

Features

Performance

- Energy Efficiency Class¹: A
- Energy² / Water³: 54 kWh / 9.5 litres
- Capacity: 14 place settings
- Programme duration⁴: 4:55 (h:min)
- Noise level: 44 dB(A) re 1 pW
- Noise Efficiency Class: B
- Noise level (silence programme): 43 dB(A) re 1 pW

Programmes/functions

- 8 Programmes: Eco 50 °C, Auto 45-65 °C, Intelligent 40 °C, Intensive 70 °C, Speed 60°, brilliantShine 40 °C, Silence 50 °C, Favourite
- Default favourite programme: Pre-Rinse
- 4 special options: Remote Start, Shine & Dry, Half Load, Speed on Demand - varioSpeed Plus
- Add-On functions via Home Connect app: Hygiene Plus, Silence on Demand
- Machine care programme
- hydroSensor

Flexible design elements

- flexComfort basket system with blue coloured touchpoints
- varioDrawer - loading of cutlery on 3rd level
- 3 stage rackMatic height-adjustable top basket
- Anti-slip protection strip in upper basket
- easyGlide wheels on upper basket
- Low friction wheels on bottom basket
- Rack Stopper to prevent derailing of bottom basket
- 2 foldable plate racks in top basket
- 8 foldable plate racks in bottom basket
- Upper rack cup shelf
- Lower rack cup shelf
- Glass rack in bottom basket

Innovations and technology

- Home Connect ready
- Zeolith energy efficient drying
- glassZone
- autoOpen dry and Heat Exchanger
- dosageAssist detergent dispenser
- iQDrive motor
- Automatic detergent-aware system
- AquaMix - Glass protection system

Design features

- varioHinge 50mm
- Black touch control operation
- Controls on top edge of door
- Interior blue emotionLight
- sideLight - indicates cycle is running
- DoorOpen Assist for handleless kitchens

- Time delay (3, 6 or 24 hours)
- acoustic end of cycle indicator
- Childlock feature - double push door open
- aquaStop®: Siemens home appliances' warranty in case of water damage – throughout the lifetime of the appliance.*
- Self-cleaning filter system with 3 piece corrugated filter
- steam protection plate
- Stainless steel interior
- Dimensions (HxWxD): 81.5 x 59.8 x 55cm

¹ Scale of Energy Efficiency Classes from A to G

² Energy consumption in kWh per 100 cycles (in programme Eco 50 °C)

³ Water consumption in litres per cycle (in programme Eco 50 °C)

⁴ Duration of programme Eco 50 °C

* Please find warranty terms under <https://www.siemens-home.bsh-group.com/uk/customer-service/warranty/additional-warranties>

iQ500, Fully-integrated
dishwasher, 60 cm, varioHinge
SN95YX02CG

Dimensioned drawings

measurements in mm



⏏ socket
() values with extension kit

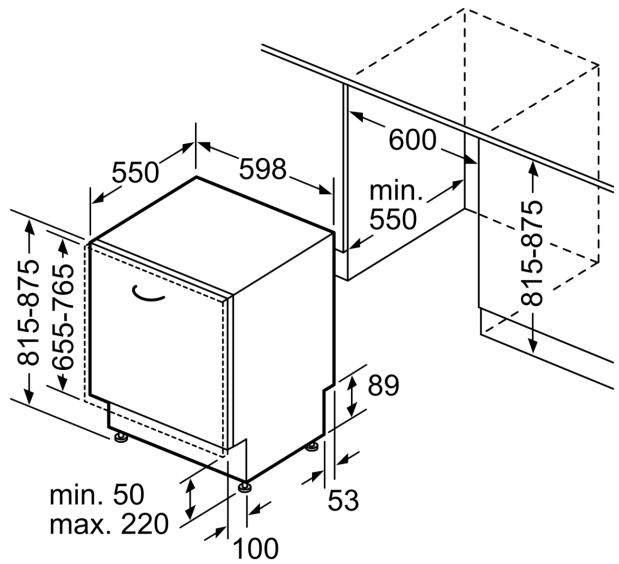

measurements in mm